

Integriti Intelligent 2 - 8 Door LAN Access Module (ILAM) P/N: 996018PCB&K Installation Manual

Overview

The basic ILAM Board supports 2 Doors/Lifts or up to 8 Doors/Lifts via UniBus 2-Door Expanders. Wiegand & RS485 Reader ports support 2 Wiegand or Clock&Data Readers, 8 Serial Readers (Salto, Aperio, etc.) or 16 Inner Range SIFER/OSDP compatible Readers. Entry & Exit Readers are supported for all Doors using SIFER/OSDP Readers. For other Reader types up to 8 Doors can each have one Reader, but for each Door requiring Entry & Exit Readers, one less Door can be used. UniBus 8-Relay Expanders and UniBus Lift Interface Boards are also compatible. (Note that enclosure size may limit the number of Doors/Readers supported) An on-board database of 100,000 Users & 100,000 access events provides continued operation & logging if Controller communication is lost. Heavy duty Lock relays, "DOTL Warning" relays and "Valid"/"Invalid" Open Collector outputs are provided.

The Module is supplied in kit form for installation in compatible Inner Range enclosures, and powered by a dedicated Inner Range Smart Power Supply. The Smart Power Supply allows power and Battery status to be monitored and/or reported via dedicated ILAM System Inputs. If overall power requirements exceed the Power Supply's limit, a separate battery-backed power supply will be required for Lock power.

Readers can be configured independently and integrated with Areas where required. Door Reed and/or Tongue Sense inputs provide "Door Forced" & "Door Open Too Long" monitoring. Spare Zones can be used for PIRs, PE beams, and other detection devices.

Specifications

Electrical

Power Supply Input:	11V to 14V DC	
Current Consumption.	Idle: 110mA	Both Lock Relays On (Unlock): 175mA (32.5mA per Lock Relay)
		Both Lock & DOTL Relays On: 200mA

NOTE. These figures do NOT include the current required by:

- Locks and any peripherals such as Lamps or Warning devices, etc. being powered from LOCK+, DET+ or LAN+.
- Readers or peripherals such as Lamps or Warning devices etc. being powered from the V+, +VR1 and +VR2 Reader terminals.
- UniBus Boards and any of the devices and peripherals listed above powered by UniBus Board power outputs.

Power Supply Outputs:	<u>Output Current Limit</u>	<u>Voltage</u>
DET+ & UniBus:	1.2A *	13.75VDC
RS485 LAN+	1.2A *	13.75VDC
+VR1/+VR2 Output:	250mA maximum	+5V DC / +13.75V DC. (Voltage selected by LK2 & LK3)
* Maximum Total Ancillary Current:	1.2A (DET+, UniBus, LAN+, V+, +VR1 & +VR2 combined)	

Lock +/- Power Input (T10) 30V DC maximum.

Relay Contact Ratings. LOCK: 5 Amps @ 30V DC. DOTL: 1 Amp @ 30V DC.

"VAL"/"INV" Aux. Output Rating: Open Collector outputs. 100mA @13.75V DC. Non-inductive loads only.

Overcurrent Protection. T4 '+VR1' AND T7 '+VR2': 250mA Self-resetting PTC Resistor. These outputs must only be used to supply power to the Reader and associated Reader LEDs and Piezo beeper. OTHER: Provided via self-resetting electronic fuses on the Integriti Smart Power Supply connected to the P2 "External Power" connector. If activated, removing the additional load or short circuit from the relevant output will restore the output to normal operation.

Relay Auxiliary ID Numbers - ILAM	Door 1	LOCK: Inn:X01	DOTL: Inn:X09
	Door 2	LOCK: Inn:X02	DOTL: Inn:X10
- UniBus 2-Door Expanders	Door 3 (UB1 D1)	LOCK: Inn:X03	DOTL: Inn:X11
	Door 4 (UB1 D2)	LOCK: Inn:X04	DOTL: Inn:X12 etc...

Mechanical

PCB dimensions: Length: 200mm / 7.9" (7 ⁷/₈") Width: 94mm / 3.7" (3 ³/₄") Depth: 46mm / 1.8" (1 ⁷/₈")

Installation environment: 0° to 49° Celsius (32° to 120° F) and 15% to 85% Relative humidity (non-condensing)

PARTS LIST

- Intelligent LAN Access Module PCB assembly.
- Installation Manual. (This document)
- Installation Kit containing:
 - 6 x Metal M3 PCB Mounting Clips.
 - 1 x Cable; Chassis Earth to PCB. 400mm.
 - 6 x M3x10mm screws.
 - 1 x Integriti ILAM enclosure label.
 - 2 x 8 Way plug-on screw terminals.
 - 2 x 4 Way plug-on screw terminal.
 - 4 x 3 Way plug-on screw terminals.
 - 8 x 2 Way plug-on screw terminals.
 - 1 x 6.3mm QC connector (Spare)
 - 2 x 1N4004 Protection Diodes. (For connecting across lock coil)
 - 20 x 2k2 End-of-line resistors. (red-red-black-brown-brown). For 8 Zone/Button Inputs plus 2 x spare.
 - 1 x 0.1" Jumper Links. (Spare or for RS485 Reader termination if required)

IMPORTANT NOTES

- 1) The Intelligent LAN Access Module is identified on the Integriti Controller (ISC or IAC) LAN as an 8-Door Reader Module (I).
- 2) a) A dedicated Inner Range Smart Power Supply is highly recommended & must be used if UniBus boards are connected. Choice of Power Supply will depend on Reader power, Lock power & Battery re-charge time requirements. The following options are a guideline:

Module + 1 UniBus Board:	Integriti 3A Smart Power Supply
Module + 2 or more UniBus boards:	Integriti 3A, 8A or 10A Smart Power Supply
- b) The Ancillary/3rd Party PSU Cable or External PSU Bypass Link combine the Module power, RDR+ & LAN+, which may allow a fault on one of these supplies to impact the other supplies. These cables should not be used on an ILAM.
- 3) Ensure that the current required by UniBus Boards and their peripherals does not cause the power supply current limit to be exceeded and that adequate battery charging current is available to meet battery re-charge time requirements.
- 4) A separate, regulated, battery-backed power supply such as an Inner Range 3A Smart Power Supply, is recommended for Lock power. Alternatively, an Inner Range 8A or 10A Smart Power Supply with appropriate battery capacity may be used to power the Module, Readers, Locks & other peripherals if load & battery charging requirements are within the Power Supply's limits. The Switched DC Power Hub (P/N:995916) can provide dedicated fuse protection for each Lock or 'Lock +/-' input if required.
- 5) Firmware/Software Compatability. - ISC / IAC Firmware: V3.0 or later. - Integriti Software: V3.0 or later. Latest Firmware & Software versions are recommended.
- 6) UniBus: A maximum of 6 UniBus Boards in total can be connected. *See p7 for details and the limits on each UniBus type.*
- 7) The standard EOL Resistor scheme for Integriti/Infiniti products is 2k2 / 2k2. Systems with Controller firmware V3.3.4 or later support 2k2/2k2 and 2k2/6k8 schemes by default. The 2k2/6k8 scheme is still required for LAN Modules & UniBus boards connected to Integriti Controllers with firmware prior to V3.3.4. Upgrading to latest Controller firmware is recommended.
- 8) Fire Protection. This product must be installed into a suitable non-flammable equipment enclosure ensuring that the enclosure has been installed onto a non-flammable surface and away from all flammable materials. Any Conduit entry points that have had the knockout removed but are not used, must also be resealed using Conduit Plugs.
- 9) Devices powered from Inner Range Power Supply outputs must be rated to operate with a power supply of up to 14 VDC except when powered from a Reader Power output that has been configured for +5V DC (i.e. +VR1 or +VR2).

REGULATORY INFORMATION

UL294 Requirements

- Wiring methods shall be in accordance with the National Electrical Code (ANSI/NFPA70), local codes, & the authorities having jurisdiction.
- The System Controller, this Module and other remote Modules and UniBus in-cabinet expansion boards are acceptable for indoor use only and must be installed within the protected premises.
- The AC power cord must not be plugged into an outlet controlled by a switch.
- The ILAM must be installed in a UL listed Inner Range Enclosure & powered by a UL listed Inner Range Smart Power Supply.
- If a separate power supply is utilized for ancillary power (e.g. For electric locks), the power supply must be a UL Listed Access Control or Burglar Alarm, Low Voltage Class 2, Power-Limited, power source capable of a minimum of 4 hours standby power.
- All cabling must be UL Listed and/or Recognized wire.
- All interconnecting devices must be UL Listed.
- The Integriti access control system must be used with UL listed Card Readers. The following examples of Listed Readers are compatible:
 - Inner Range SIFER Reader & SIFER-Keypad
 - HID iClass, iClass SE & Proximity
- Fuses. CAUTION - FOR CONTINUED PROTECTION AGAINST THE RISK OF FIRE, REPLACE WITH ONLY THE SAME TYPE AND RATING OF FUSE.

FCC Statement

Information to the user (FCC Part 15.105)

Class B Product:

This equipment has been tested & found to comply with the limits for a Class B digital device, pursuant to Part 15 of the FCC Rules.

These limits are designed to provide reasonable protection against harmful interference in a residential installation. This equipment generates, uses and can radiate radio frequency energy and, if not installed and used in accordance with the instructions, may cause harmful interference to radio communications.

However, there is no guarantee that interference will not occur in a particular installation. If this equipment does cause harmful interference to radio or television reception, which can be determined by turning the equipment off and on, the user is encouraged to try to correct the interference by one or more of the following measures:

- Reorient or relocate the receiving antenna.
- Increase the separation between the equipment and receiver.
- Connect the equipment to an outlet on a circuit different from that to which the receiver is connected.
- Consult the dealer or an experienced radio/TV technician for help.

Warning: Any changes or modifications not expressly approved by Inner Range Pty Ltd could void the user's authority to operate the equipment.

ISED (Canada)

L'émetteur/récepteur exempt de licence contenu dans le présent appareil est conforme aux CNR d'Innovation, Sciences et Développement économique Canada applicables aux appareils radio exempts de licence. L'exploitation est autorisée aux deux conditions suivantes :

1. L'appareil ne doit pas produire de brouillage;
2. L'appareil doit accepter tout brouillage radioélectrique subi, même si le brouillage est susceptible d'en compromettre le fonctionnement.

CAN ICES-3 (B) / NMB-3(B)

INSTALLATION AND SAFETY INSTRUCTIONS

Mounting the Unit.

- The Integriti ILAM is normally installed on the mounting plate or in another suitable location in an Inner Range Powered Enclosure using the six Metal Mounting Clips and M3 x 10mm screws provided.
See the Medium Enclosure Example layout diagram on page 7 and Important Note 8 on p2.
- If not already installed, the Tamper Switch is inserted into the hole provided in the Tamper switch bracket.
 - The Tamper switch is wired to the “TAMP” input (T9) on the ILAM PCB as shown in the wiring diagrams.
 - The Tamper Switch bracket must then be positioned in the slot provided in the chassis.
See pages 4 & 5 and the equipment enclosure installation manual for details.
- Using the Earth cable provided, connect the Earth Terminal on the ILAM PCB to either:
 - The M4 Earth Stud (if provided) or another suitable point on the base of the metal enclosure.
 - The Earth Terminal on the Power Supply. e.g. Integriti Smart PSU.
- Set the Module Number using DIPswitches 1 to 7. *See table below.*
- Wire the Readers, Locks, Input/Output devices & Power Supply/s according to the details on pages 4 to 7. Door Reed & Tongue Sense must be wired using End-of-Line (EOL) Resistors. REX & REN Inputs should also be wired using EOL Resistors which may be required by local standards/regulations. A Module programming option (“Override EOL”) allows REX/REN to be wired without EOL for compatibility with existing installations if allowed (default option). ARM Inputs do not require EOL Resistors.

Module Numbering

The Module number equals $n + 1$, where n is the binary number set on the DIPswitches.

SW1. DIPswitches 1 to 7 are used to set the Module number. *See table below and PCB layout on page 4.*

Module No:	DIPswitch:	1	2	3	4	5	6	7	8
	Binary value:	1	2	4	8	16	32	64	n/a
1		off	off	off	off	off	off	off	Always Off.
2		ON	off	off	off	off	off	off	
3		off	ON	off	off	off	off	off	
4		ON	ON	off	off	off	off	off	
5		off	off	ON	off	off	off	off	
6		ON	off	ON	off	off	off	off	
7		off	ON	ON	off	off	off	off	
8		ON	ON	ON	off	off	off	off	
through to									
64		ON	ON	ON	ON	ON	ON	off	
...99		off	ON	off	off	off	ON	ON	

Status and Fault LEDs

See pages 4-5 for location.

L1	RX.	Valid LAN packet received or LAN/System Fault indication. <i>See table below.</i>
L2	TX.	LAN packet sent or LAN/System Fault indication. <i>See table below.</i>
L3	FAULT.	ON = LAN Fault. <i>Refer to L1/L2 table below for details.</i> FLASHING: - & L1 FLASHING = Hardware fault. Return for repair or replacement. - & L2 FLASHING = Firmware fault. Return for repair or replacement.
L4	SYS.	ON = Module starting up. FLASHING = Module is powered and firmware running OK.
L5/L6	Reader D0/D1	Data Receive indication for both onboard Reader Inputs.
L10/L11	RX/TX	Reader RS485 port (T1) data receive & transmit indication.
L12/L13		“+VR1” / “+VR2” Fault indication. e.g. Over current.
L14	UniBus	FLASHING = Idle. No UniBus boards connected. OFF = OK. UniBus Board/s communicating correctly. ON = Fault. Problem with one or more UniBus Boards. e.g. Address conflict.
L16/L17		Lock 1 / Lock 2 Relay On indication.

L1	L2	EXPLANATION / REMEDY
ON	ON	Module is un-addressed. (Not communicating with the Controller)
ON	OFF	Too many Modules on the Network. Check limits and licencing.
OFF	ON	Module type unknown. Controller firmware upgrade required.
Flash	ON	Duplicate Module. Number already in use by module of the same type.
Flash	Flash	Module number selected is too big. Select a lower Module number that is not already in use or check limits and licencing.
ON	Flash	Module disabled. (OFF/Flash in earlier firmware versions)

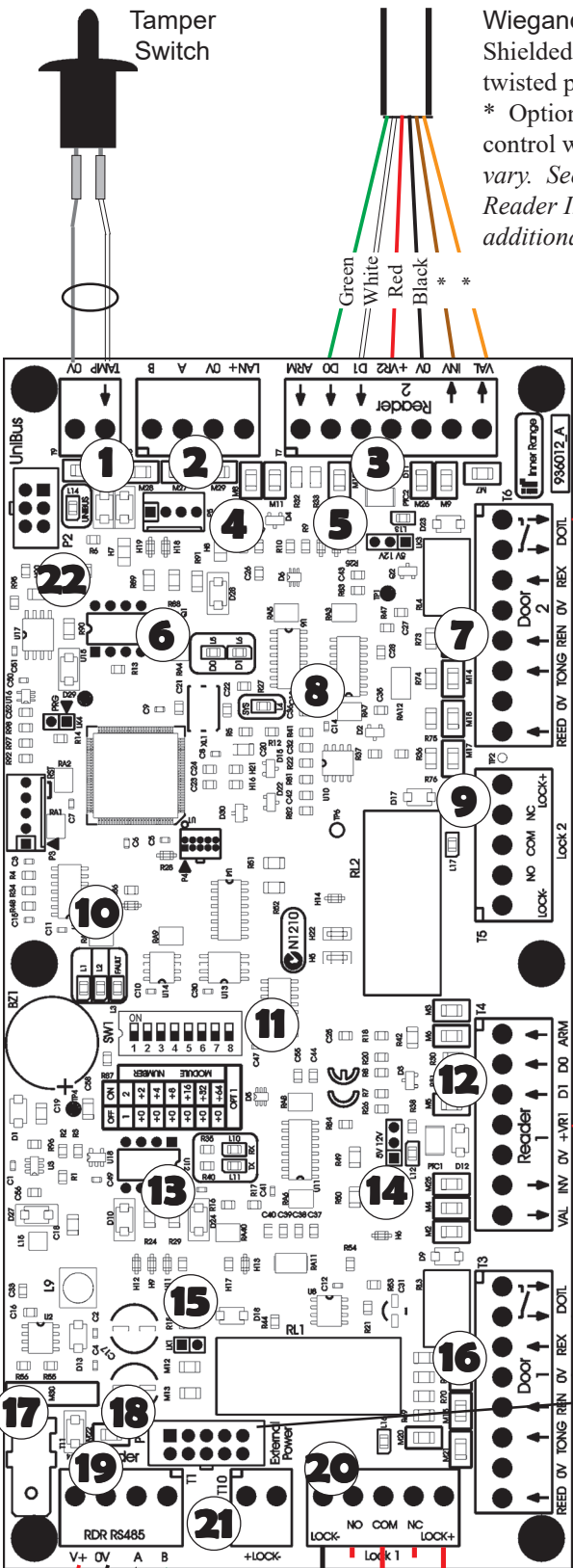

Tamper Switch

Wiegand Reader Cable
 Shielded data cable (DO NOT use twisted pair).
 * Optional LED &/or Beeper control wires. *Wire colours may vary. See pages 5 & 6 and the Reader Installation Manual for additional details.*

Input Device Supervision: End-of-line Resistors must be installed on the detection devices. Typical Detection devices with *Normally Closed* Alarm contacts and *Normally Closed OR Normally Open* Tamper Contacts are wired as shown below and in the ISC or IAC Installation Manuals.

ARM Button. Programming options allow a nominated Area to be armed if a valid card is presented to the associated Reader while the "ARM" button contact is Closed.

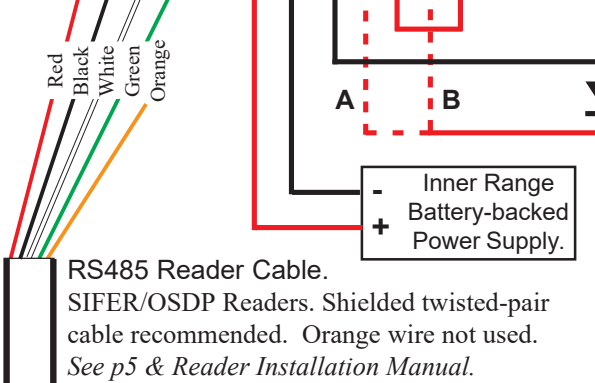

RS485 Reader Cable.
 SIFER/OSDP Readers. Shielded twisted-pair cable recommended. Orange wire not used.
 See p5 & Reader Installation Manual.

A Power to Un-Lock
 B Power to Lock

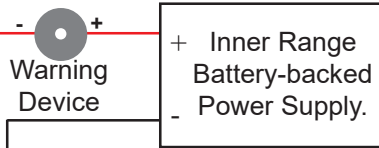

DOTL Warning Device powered from the external Power Supply.



Normally Open Button contact.
 - ARM button.
 - REX & REN if "Override EOL" option Enabled.

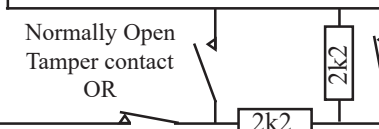

Normally Closed contact.
 - REED & TONGUE. (Must be supervised Contacts)
 - REX & REN if "Override EOL" Disabled. (Recommended method)
 Note: Tamper contacts are not normally relevant to REX/REX devices)

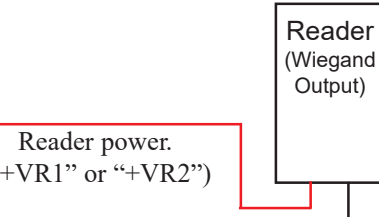
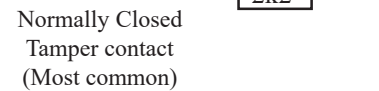

DOTL Warning via Reader internal Piezo Warning Device.

Connecting Power

P1. 'External Power'. Connect the 10-way External Power Bus Cable between P2 on the Inner Range Smart Power Supply and P1 "External Power" on the ILAM. In-cabinet connections. Wiring connected to these terminals must not exit the enclosure.

Lock Wiring Example

A 1N4004 Protection Diode (supplied) is fitted as close as possible to the lock. Cathode (bar) to +.

T10 (+LOCK-) is a dedicated Lock Power Supply Input for both Locks & is the only power source for the Lock +/- terminals on T2 & T5. The external power supply must be overload/fuse protected.

Heavy duty Fig. 8 cable, minimum 21AWG (14/0.20) recommended for Power & Lock wiring. (Check Lock manufacturer's installation manual)

WIRING TERMINALS, OPTION LINKS AND INDICATOR LAMPS

1. **T9. Tamper Switch Connection**
Two 4.8mm Quick Connect terminals are provided in Inner Range Enclosure installation kits for terminating a 2-core cable to the switch. The cable is then connected to the "TAMP"/"0V" input (T9) on the ILAM PCB.
Switch is Open-circuit when plunger is depressed.
In-cabinet connection. Wiring connected to these terminals must not exit the enclosure.
See drawing opposite.
2. **T8. Integrati RS485 LAN connection.**
See "RS485 System LAN Wiring" on p6.
3. **T7. Reader 2 connection.** *See 'T4' below for details.*
4. **P5. Ancillary LAN.** Temporary commissioning & troubleshooting connection for a Terminal (e.g. EliteX) using the Ancillary LAN cable P/N: 993028.
5. **LK3 / L13. Reader 2 Supply voltage and Fault LED.**
"5V" setting: +5VDC "12V" setting: +13.75VDC
See details on p6 & 7.
6. **L5. D0.** Data 0's I/P either Wiegand Reader Port.
L6. D1. Data 1's I/P either Wiegand Reader Port
See 'Status & Fault LEDs' table on p 3.
7. **T6. Door 2 Input/Output connections.**
See 'T3' for details.
8. **L4. SYS. Flashing = OK.** *See Page 3 for details.*
9. **T5 / L17. Lock 2 Relay & indicator LED.**
See drawing opposite. Relay Specifications are on page 1.
- 10 **L1** LAN Data Receive / Fault indication.
L2 LAN Data Transmit / Fault indication.
FAULT LAN Comms Problem.
See 'Status & Fault LEDs' table on p 3.
11. **DIPswitch SW1: Switch 1-8.**
Module number. *See table on p 3.*
12. **T4. Reader 1 connections.**
See drawing opposite & "Wiegand Reader Wiring" on p6.
VAL Reader "Valid" LED/Beeper output.
INV Reader "Invalid" LED/Beeper output.
See additional details on p7.
0V Reader 0 Volt (-ve) connection.
+VR Reader power supply. Selectable 5V/12V via LK2 (Reader 1) and LK3 (Reader 2)
D1 (CLK) Reader Data or Clock input.
D0 (Data) Reader Data input.
ARM Input for optional Area ON operation.
EOL resistors NOT required.
13. **L10. RX** Reader RS485 RX. *See table on Page 3.*
L11 TX Reader RS485 TX. *See table on Page 3.*
14. **LK2 / L12. Reader 1 Supply voltage and Fault LED.**
See 'LK3 / L13' above.
15. **LK1. TERM. Reader RS485 Termination.**
Normally only fitted if advised by Reader manufacturer or Inner Range Technical Support.
Refer to RS485 Reader installation manual.
16. **T3. Door 1 Input / Output connections.**
See Drawings opposite.
REED Reed Switch Input. EOL resistors required.
0V 0 Volt return for Input connections.
TONG Optional Tongue Sense Input.
EOL resistors required.
REN Entry Button I/P. EOL Resistors Optional.
REX Exit Button Input. EOL Resistors Optional.
See Step 5 on p3 for REX/REN I/P information.
DOTL "DOTL Warning" Relay terminals.
Normally-open Dry Relay Contacts.
If connected to Reader Beeper wire, connect other contact to 0V. *See p1 for Specifications.*
17. **T11. Earth Lug.**
Connect to the earth stud in the base of the enclosure using the Earth Cable provided in the installation kit.
18. **P1. External Power.**
NOTE: Does not provide Lock Power.
Connects to:
- An Inner Range Smart Power Supply using the cable provided with the Power Supply. (Highly Recommended)
- Other +/- outputs on an Inner Range Smart Power Supply using cable P/N: 996794. *See Important Note 2 b) on p2.*
In-cabinet connections. Wiring connected to these terminals must not exit the enclosure.
Refer to drawing opposite and to Specifications - Electrical on page 1 for proper loading.
19. **T1. RDR RS485.**
Connection for Readers with RS485 data format such as Inner Range SIFER Smart Card Readers or 3rd Party OSDP Readers. Pair 1: Data A/B Pair 2: V+/0V.
NOTE: Other RS485 devices such as LAN Isolators & Fibre Modems must not be connected to this port.
To extend the length of the Reader pigtail cable, twisted pair cable must be used. Shielded cable is recommended:
See Reader Installation Manual for full wiring details.
20. **T2 / L16. Lock 1 Relay & indicator LED.** *See 'T5/L17'.*
21. **T10. Lock +/-.** Power input for "Lock+/-" on T2 & T5. The Power Supply connected to these terminals must be power-limited (fused) & battery-backed.
Refer to drawing opposite and Specifications - "Lock Relay Contact Rating" on p1 for max voltage & current.
22. **P2 / L14. UniBus.**
Connector & Status LED for UniBus Boards. e.g. 2-Door Exp., 8 Relay Exp. or Lift Exp. In-cabinet connection. Wiring connected to these terminals must not exit the enclosure. **NOTE: An External Power Supply must be connected to P1 if any UniBus boards are connected.**
See page 7 and Note 2 on page 2.

Additional Field Wiring Information

RS485 SYSTEM LAN WIRING

The LAN is connected using twisted-pair cable. e.g. RS485 / RS422 shielded data cable or Category 5/5e cable.

One pair is used for Data A & B, and the other pair is used for LAN+ (if required) & 0V.

Depending on your system, refer to the relevant Controller Installation Manual for detailed information on RS485 System LAN wiring. e.g. *The Inception LAN Installation Guide, ISC Installation Manual or IAC Installation Manual.*

- The ILAM is normally powered by a local Inner Range Smart Power Supply, so the LAN+ terminal is not normally connected. LAN+/0V wires from a Controller, other locally-powered LAN Module, or other suitable Power Supply may be connected if the ILAM does not have a local power supply and is sourcing power from that other device. Heavy duty cable may be required.
- The LAN+ terminal may be used to provide power to LCD Terminals (e.g. EliteX Terminals) in the vicinity of the ILAM Module. See diagram B. Ensure that adequate power supply current and backup battery capacity are available from the power supply source when powering LCD Terminals from LAN+.
- If the incoming LAN cable provides a LAN+ power source, then the LAN to subsequent Modules such as LCD Terminals may derive power from the incoming LAN cable if required. * See LAN+ wire represented by dotted lines in Diagram A.

NOTE: Any LAN+ wires that provide a power supply source must never be connected together.

- Current drawn from LAN+ and other power supply outputs on the Module must not exceed the limit of the Power Supply source.

Diagram A.

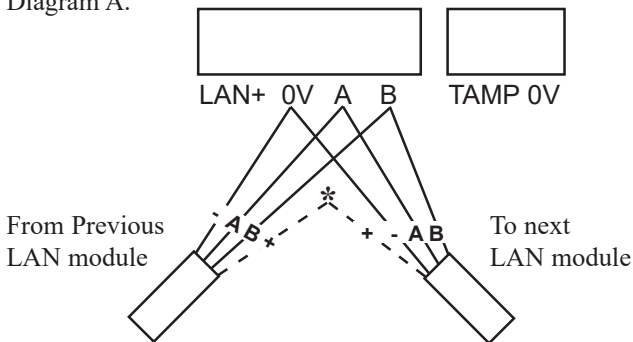
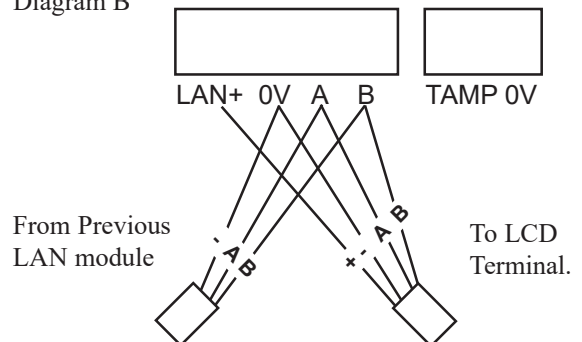

Diagram B



WIEGAND READERS; WIRING & LINK SETTINGS

The Reader power supply voltage (+VR1 / +VR2) can be set to +5VDC or +13.75VDC. Before connecting a Reader, set Link LK2 (Reader 1) and/or LK3 (Reader 2) for the correct Reader power supply voltage. See table below & pages 4-5.

Always refer to Reader Installation guides to check wiring details. Readers connected to T4 or T7 should be wired with Shielded Data cable. **DO NOT use twisted pairs!**

Reader power and data connections & power link settings for some common Readers are shown in the table below.

READER	D0 R#	D1 R#	+VR#	0V	LK2/LK3
Omron Mag Swipe	Brown (Data)	Red (Clock)	Yellow	Green	5V
Inner Range Secure40 Prox Reader	Green	White	Red	Black	12V
HID/Indala with pigtail cable/flying leads	Green	White	Red	Black	
HID with screw terminals	Data 0	Data 1	+VE	GND	
HID Swipe / Insertion / Turnstile Wiegand Card Readers					5V
HID ProxPoint / MiniProx / ThinLine / iClass R10 / R15 / R30 / R40					5V
HID ProxPro. HID iClass R90 / RKL55					12V
Indala. SlimLine(Mullion) / WallSwitch / PinProx / ValueProx					5V
Indala. Standard / Mid Range 610 / MasterProx / Long Range 620					12V

NOTES:

- 1) The "12V" Reader Power Link setting provides +13.75V to the +VR1/+VR2 output. When the "12V" option is selected, Readers connected to these ports must be rated to operate with a supply voltage of up to 14V DC.
- 2) It is recommended that Readers with wide supply voltage ranges (e.g. 4V to 14V, 5V to 16V, etc.) are powered with 5V unless 12V is required for a longer read range.

VALID/INVALID Auxiliary Outputs.

The Auxiliary Outputs “VAL” and “INV” are designed for non-inductive loads only and can switch up to 100mA at 12Volts DC. They are primarily intended to be connected to Reader LED &/or Beeper control wires to provide visual &/or audible feedback. The LED &/or Beeper control wires provided on many Readers can normally be wired directly to the “VAL”/“INV” outputs on the Module if required. (The dropping resistor is usually built in to the reader) Check information supplied with the Reader for LED and Beeper control details before connecting.

If “+VR1” or “+VR2” is used to power external LEDs, or dropping resistors are not provided in the Reader, connect a 1.2kOhm resistor between +VR & the LED Anode.

ZONE INPUT WIRING EXAMPLES

Refer to the Integriti Controller Installation Manuals (ISC or IAC) for examples of Zone Input wiring for common detection devices.

UNIBUS BOARD EXPANSION OPTIONS

Connector P2 on the ILAM is the Integriti UniBus Port. UniBus is an in-cabinet connection bus for local expansion boards which are installed in the same enclosure using the 270mm cable supplied with the board or other length UniBus cable purchased separately.

UniBus Cable P/N: 996791XL = 675mm 996791LL = 475mm 996791SS = 150mm

The “UniBus” port on an ILAM can be used to provide additional Doors & Readers, Auxiliary Relay outputs and Lift interfacing.

Types & Limits

Up to 6 UniBus boards in total may be connected to a host Module.

See Note 2 on page 2.

The limit on the number of any particular type of UniBus board that can be connected is determined by the total number of entities supported by the Module & UniBus board and limits that may be imposed by on-board hardware.

UniBus 2-Door Expander:

Up to 3 are supported. (ILAM supports up to 8 Doors)

UniBus 8-Relay Expander:

1 is supported assigned to Auxiliaries 9 to 16. (ILAM supports up to 16 Auxiliaries, but Auxes 1 to 8 are reserved for Lock Relay control) Note that the on-board DOTL Relays are also assigned to Auxes 9 to 16.

UniBus 16-Floor Expander:

Up to 6 are supported. (ILAM supports up to 96 Floors)

When a new UniBus board is added to a Module, the “Unsecured” System Input will be triggered to indicate that a new UniBus board is present.

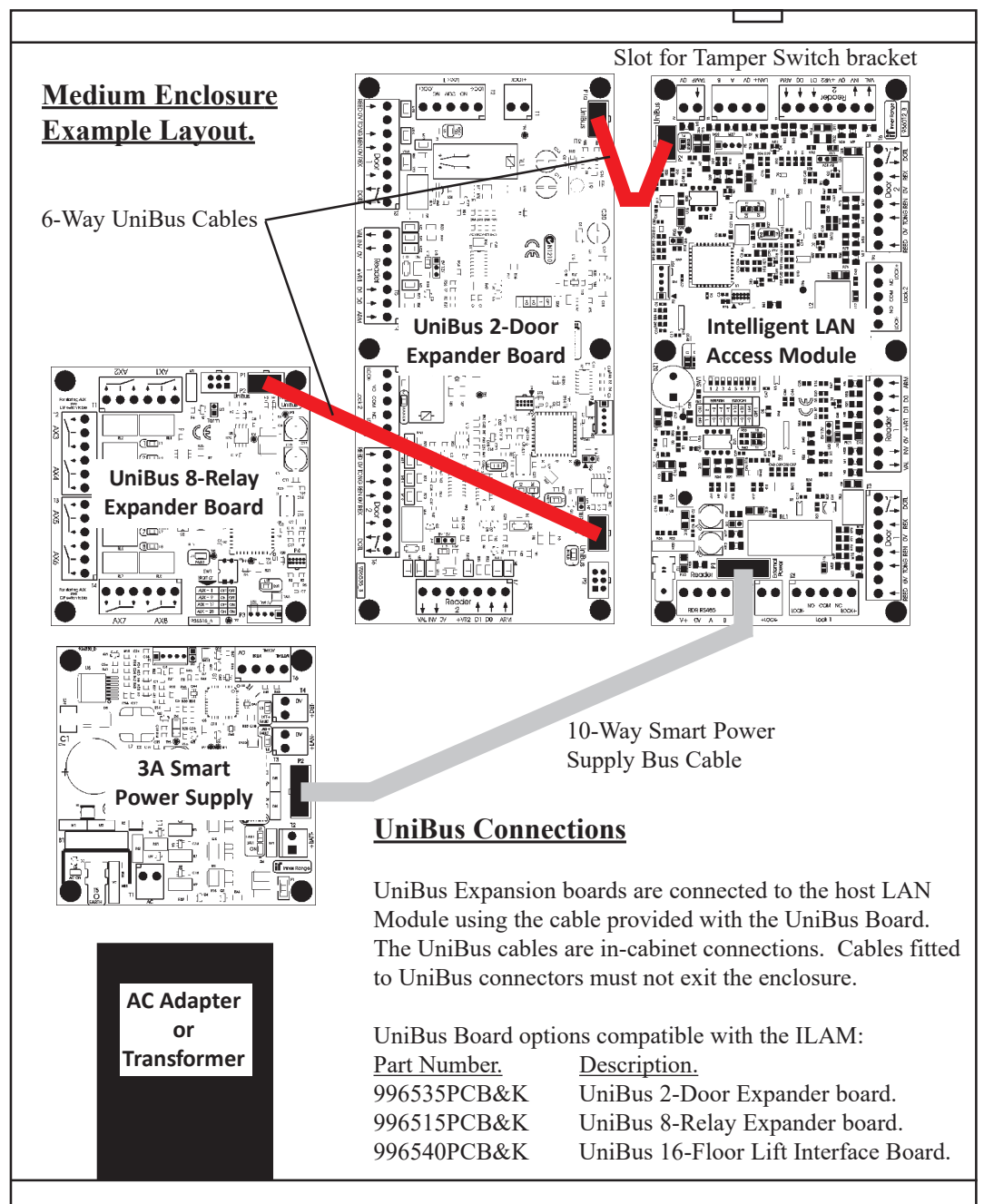

UniBus Connections

UniBus Expansion boards are connected to the host LAN Module using the cable provided with the UniBus Board. The UniBus cables are in-cabinet connections. Cables fitted to UniBus connectors must not exit the enclosure.

UniBus Board options compatible with the ILAM:

<u>Part Number.</u>	<u>Description.</u>
996535PCB&K	UniBus 2-Door Expander board.
996515PCB&K	UniBus 8-Relay Expander board.
996540PCB&K	UniBus 16-Floor Lift Interface Board.

COMMISSIONING, TESTING & TROUBLESHOOTING

Pre Power Up Testing

The following checks are performed with all AC power and Batteries disconnected.

Physically inspect cabling for any signs of cable damage or short circuits.

- Unplug the RS485 LAN connectors from the Circuit Board.
- Using a Multimeter set to the ohms range, check for short circuits between POS and NEG, and POS and the metal chassis.
- Also check for short circuits between A and NEG, and B and NEG.
- Restore the LAN connectors.

Power Up Testing

Apply AC power and connect the Batteries. Perform the following tests with a Multimeter set to DC Volts or a DC Voltmeter.

- Measure the DC Voltage between the DET “+” & “-” Terminals on the Inner Range Smart Power supply. +13.75V +/- 2%
- Measure the DC Voltage between the BATTERY + & - Terminals on the Inner Range Smart Power supply. +13.75V +/- 2%
- Measure the DC Voltage between the +VR1/+VR2 & 0V output Terminals on the SLAM. +5V or +13.75V +/- 2%
- Measure the DC Voltage between the RS485 LAN+ and 0V Terminals on the SLAM. +13.75V +/- 2%
- Check the FAULT and STATUS LEDs on the SLAM. The “SYS” LED should be flashing slowly. If not, check the table on page 3.

Status and Fault LEDs

Details of the Status and Fault LED indications are provided on page 3.

Note: If a firmware update is performed, the internal memory may need to be erased. This will be indicated by L1/L2/L3=Off, L5/L6=On and it may take up to 1 minute for the Module to resume normal operation.

Zones and System Inputs

INTEGRITI: The status of any Zone or System Input can be viewed in the Integrity System Designer Software or via the LCD Terminal Test Menu. <MENU>, 4, 1.

Integrity Zone Input Programming Notes

Detection devices with *Normally Open* Alarm contacts are wired in exactly the same manner as shown on p4 & p7.

When programming the Zone Input, however, the option to “Swap Alarm and Seal” must be set to [Y]es.

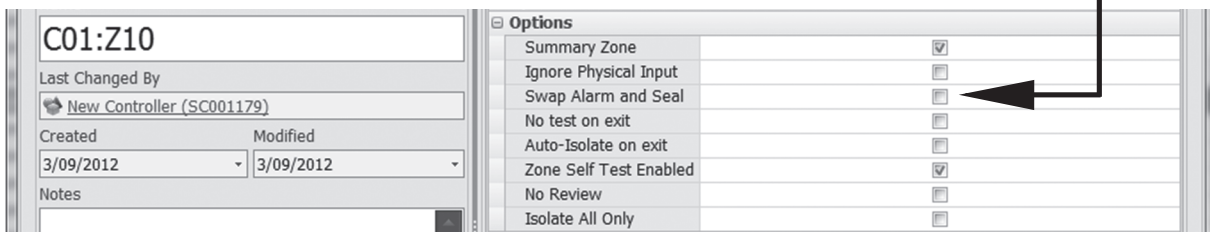

System Operation

System User operations are described in the document “A Beginners Guide to Inner Range Systems” and in the following manuals: INTEGRITI

Integrity User Manual - Elite LCD Terminal	P/N: 630026I
Integrity Colour Graphic Terminal User Manual	P/N: 636000U

System Commissioning and Routine Maintenance

Procedures for a range of Commissioning and Routine Maintenance Tests are provided in the document:

INTEGRITI: “Inner Range. Integrity Security and Access Controllers. Manufacturers recommended routine maintenance.”

Routine Maintenance Testing should be performed at intervals of not less than one year, or more frequently as required by relevant regulations, and/or as agreed with the customer.

Disclaimer

The manufacturer &/or it's agents take no responsibility for any damage, financial loss or injury caused to any equipment, property or persons resulting from the correct or incorrect use of the system or it's peripherals. The purchaser assumes all responsibility in the use of the system and it's peripherals.

While every effort has been made to ensure the accuracy of this manual, the manufacturer assumes no responsibility or liability for any errors or omissions. Due to ongoing development, this manual is subject to change without notice.

Inner Range Pty. Ltd. PO Box 9292, Scoresby, Victoria 3179, Australia. Phone: +61 3 9780 4300

Please send any comments regarding this manual to: publications@innerrange.com